

Taffeta 60 cm

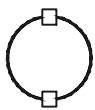

Note: *
LINES 1-2 COILED AND SHIRTBANDED TOGETHER INSIDE TABLE TRAY

①

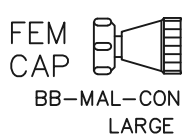

3/16x1/16x 200 cm
BB PVC MED-68



56 cm

10 cm

95 cm

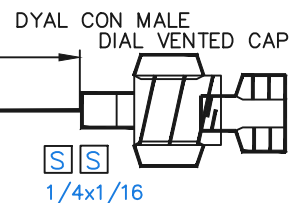

1/4x1/16

②

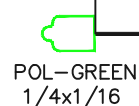

GREEN

1/4x1/16x 300 cm
BB PVC MED-68



GREEN

10 cm

130 cm

GREEN

56 cm

③



YELLOW

1/4x1/16x 290 cm
BB PVC MED-68



YELLOW

YELLOW

56 cm

115 cm

④

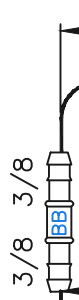

RED

3/8x3/32x 170 cm
BB PVC MED-68



RED

RED

50 cm

37 cm

⑤



BLUE

3/8x3/32x 195 cm
BB PVC MED-68



BLUE

BLUE

50 cm

42 cm

STANDARD 268

⑥

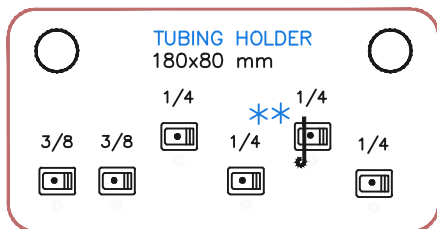

Note: **
PUT STRAP ON CLAMP

NOTE:
PUT WRAP 20x20"
ON TOP OF LINES
ON TABLE TRAY

LEFT BLIND FOAM BLOCK

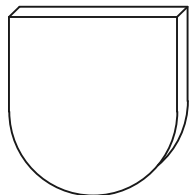

RIGHT BLIND FOAM BLOCK

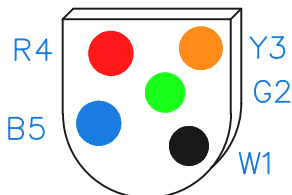
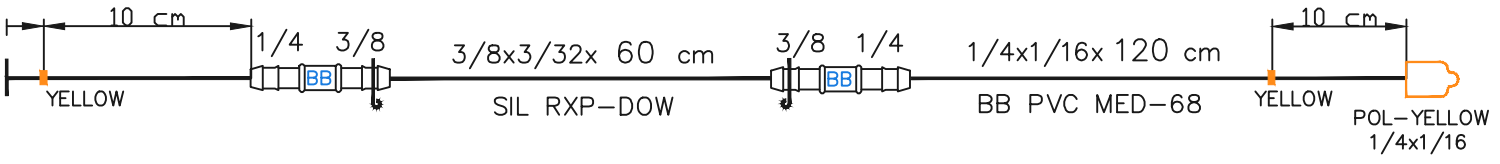
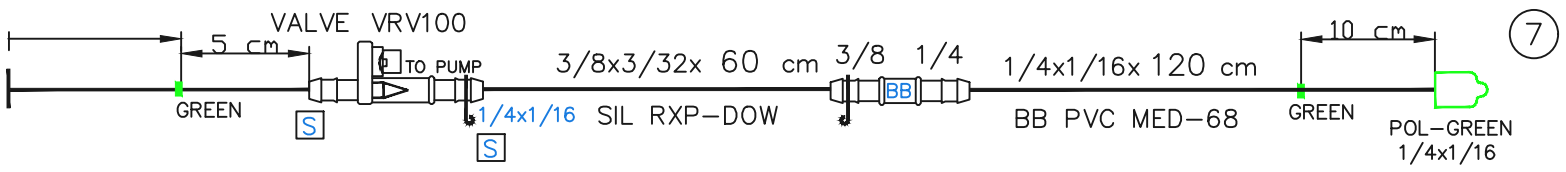
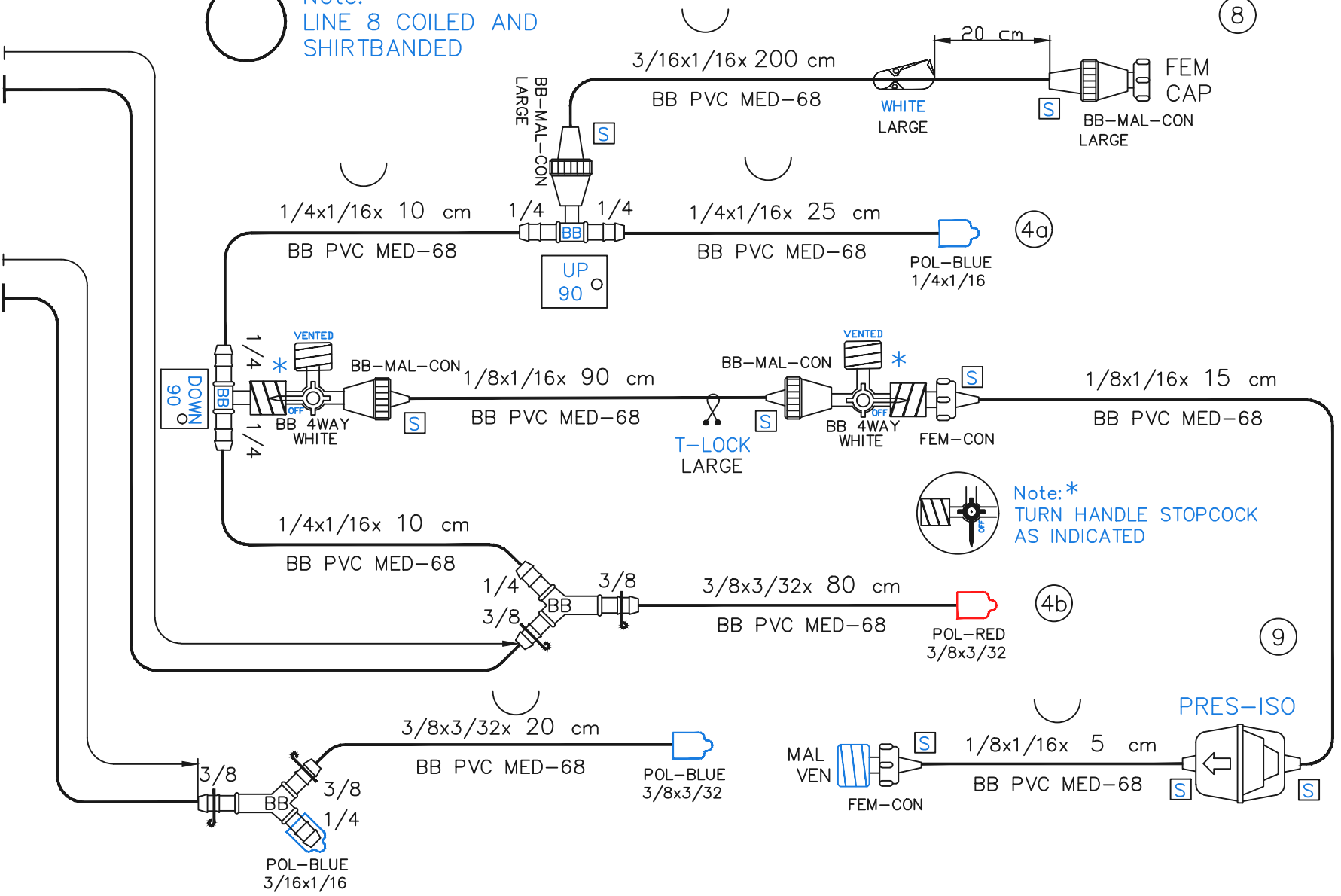

TABLE TRAY + COVER



Note:
LINE 8 COILED AND
SHIRTBANDED



Note: *
TURN HANDLE STOPCOCK
AS INDICATED

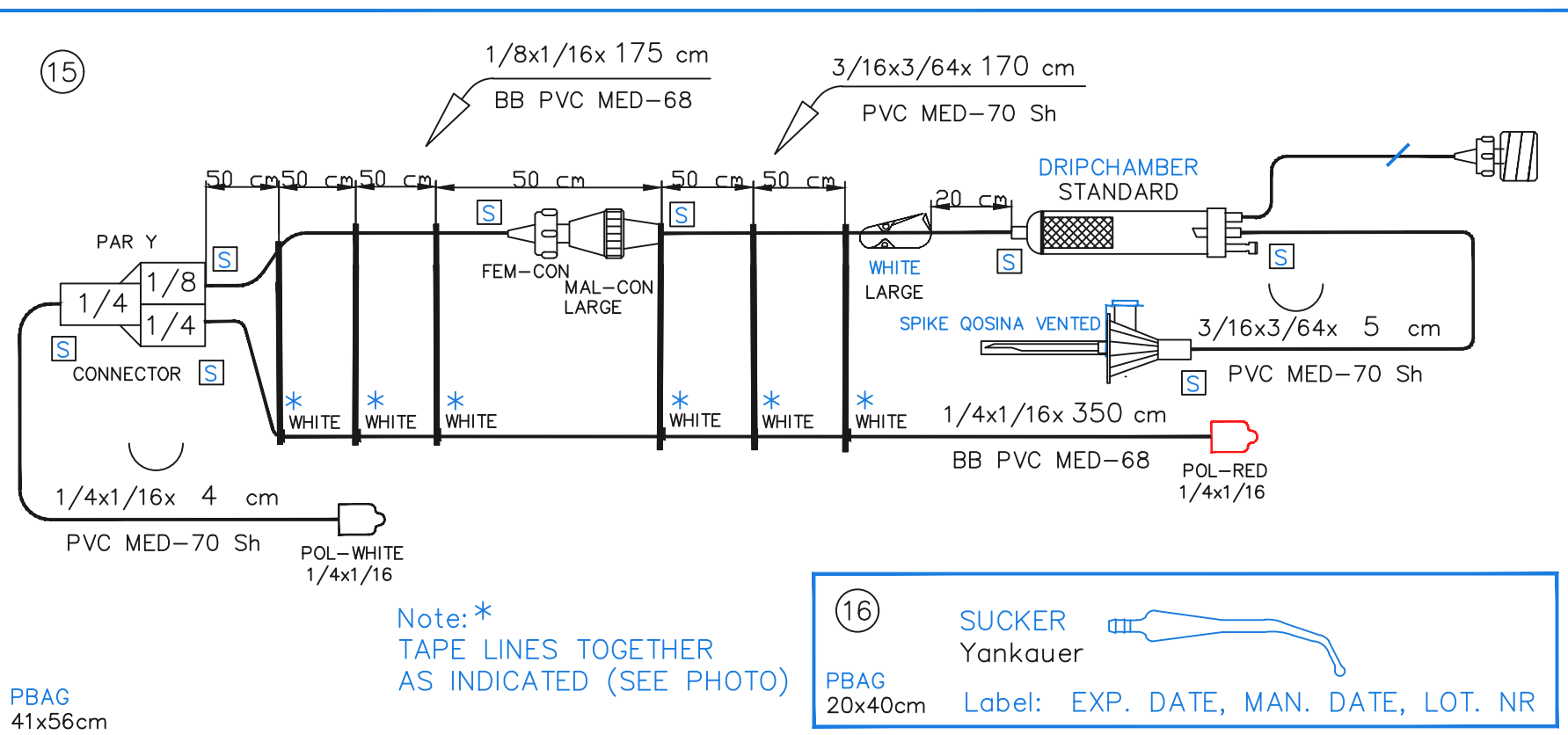
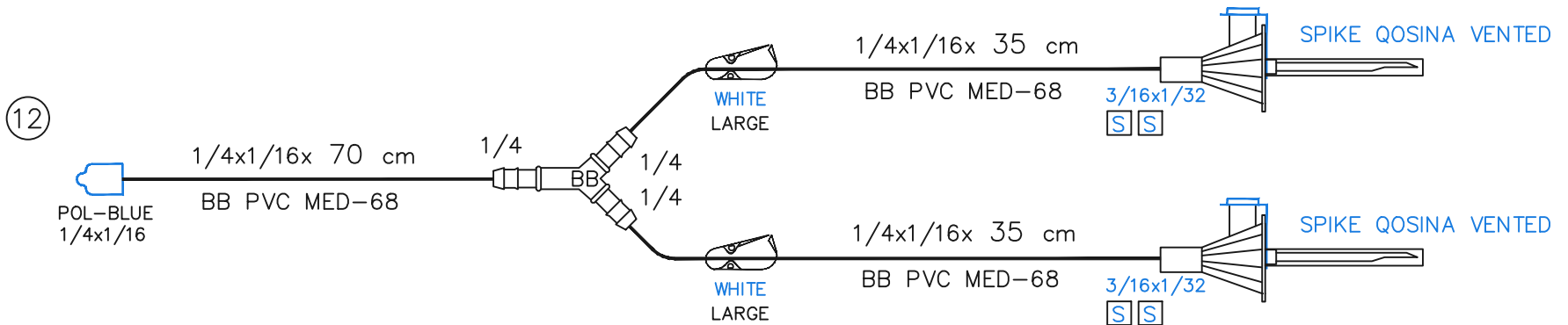
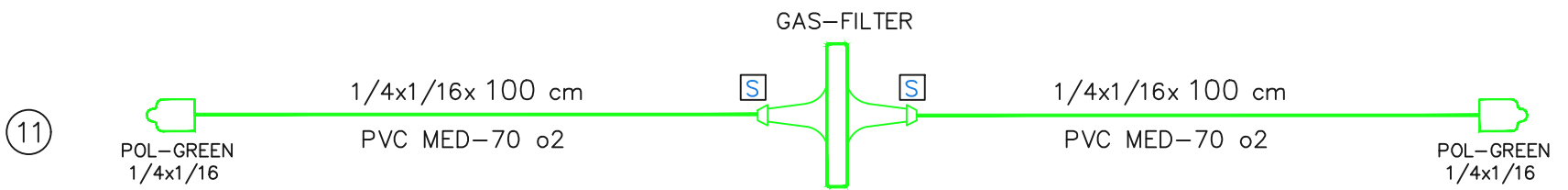
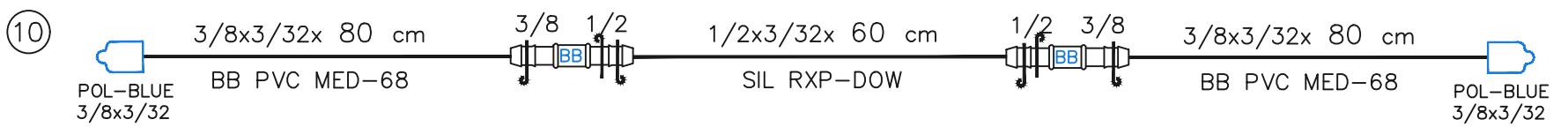

PBAG 41x56cm

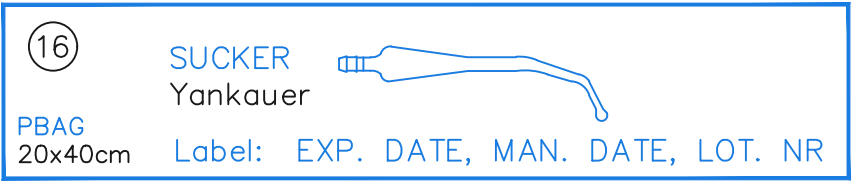

Note: remove tubing and connect as indicated
Don't remove plug

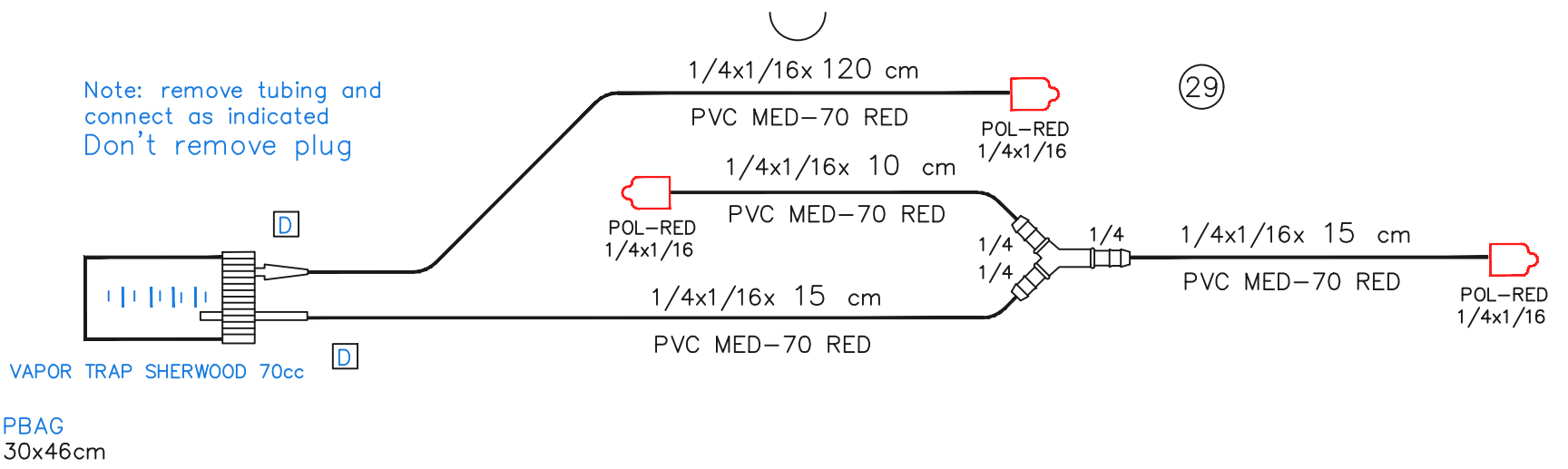

24



30

PBAG
30x46cm

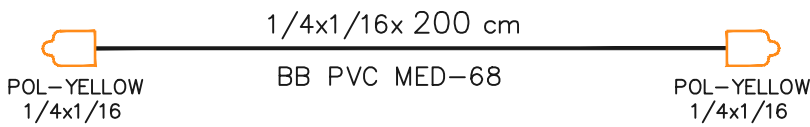

17

PBAG
10x20cm



25

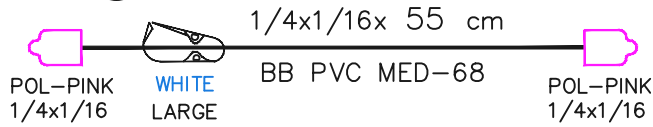

LEVEL SENSOR Jostra

18



19

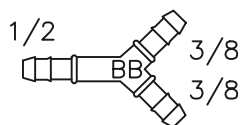

20

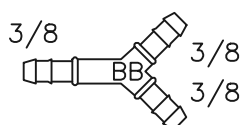

21

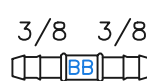

22

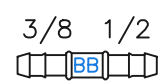

PBAG
30x46cm